

# Max Charge MC-612 Regulator Installation and Operator's Manual

## BALMAR®

### I. INTRODUCTION

The microprocessor-controlled Max Charge MC-612 is the most advanced regulator available. Designed to continually monitor battery voltage and automatically optimize charging, the MC-612 uses up to 12 time and voltage increments to ensure your batteries receive a full charge quickly and safely.

The MC-612 lets you choose from a variety of selectable preset programs to best suit your charging needs. **Its Universal Factory Program allows you to connect the MC-612 to your alternator right out of the box.** Six additional preset programs support most popular battery types, including standard and deep-cycle flooded batteries, AGM, gel, and Optima (spiral wound) technologies, as well as special settings for systems supplying halogen lighting. An easy-to-use magnetic reed switch delivers quick, precise regulator adjustment. Should your charging system require individualized adjustment, the MC-612 provides additional advanced user-defined programming options.

When used with optional alternator and battery temperature sensors, the MC-612 automatically monitors ambient alternator and battery temperatures and compensates by adjusting field output to match conditions. Alarm outputs connect to audible or visual alarms to provide warnings of dangerous system conditions.

### II. SAFETY CONSIDERATIONS

Before installing your MC-612 marine regulator, please take a moment to consider these guidelines for safe regulator installation. Failure to work safely could result in personal injury or damage to your electrical system.

1. Always disconnect your battery banks and ensure that switches are "OFF" prior to installing your regulator.
2. Remove loose-fitting clothing or jewelry, which could become entangled in your motor or other machinery.
3. Wear ANSI-approved safety glasses.
4. DO NOT attempt to modify the regulator. Alterations could result in damage to your charging system, and will void your warranty.
5. Do not attempt installation if tired or fatigued.
6. Ensure the engine has cooled before initiating installation.
7. Do not attempt installation while using alcohol or any medication that could impair your judgment or reaction time.
8. Always use the right tool for the job. Improper tool use may damage the regulator or your boat, and could result in personal injury.
9. Take time to read the manual. Equipment damage and possible injuries may result from an incomplete understanding of the installation and operation of the MC-612 regulator. If you are unfamiliar with marine electrical systems, consult with a licensed marine electrician.



### CAUTION

The following instructions are intended for use by experienced marine electrical installers. If you are not experienced at installing electrical system components, we recommend the use of a qualified marine electrical technician.

### TABLE OF CONTENTS

I.	Introduction .....	1
II.	Safety Considerations .....	1
III.	Pre-Installation Issues .....	2
	Warranty .....	2
IV.	Regulator Installation .....	3
V.	Alarm and Sensor Installation .....	4
VI.	Basic Programming .....	4
VII.	Advanced Programming .....	6
IX.	Troubleshooting .....	8
	Suggested Wiring Options .....	10-11
	Express Installation Instructions .....	12

**BALMAR®**  
FAX: (360) 435-3210

19009 61st Ave. NE, Arlington, WA 98223  
E-MAIL: [balmar@balmar.net](mailto:balmar@balmar.net)

PHONE: (360) 435-6100  
WEB: [WWW.BALMAR.NET](http://WWW.BALMAR.NET)

©Copyright 2001 Ballard Commercial Industries, Inc. Revised 3/15/2003

### III. PRE-INSTALLATION ISSUES

The following information is essential to the proper operation of your Max Charge regulator. Do not install or operate before reviewing the following:

- 1. POSITIVE BATTERY SENSE WIRE** - User supplied -- not in harness. This wire must be connected to the regulator and to a source of positive battery voltage (see Figure 3 for mounting location) to provide proper regulator operation. The regulator **WILL NOT WORK** if the sense wire is not connected to the regulator or the voltage source. The Positive **BATTERY SENSE WIRE MUST BE FUSED**. A 1-amp ATC fuse and holder are included with the regulator and harness.
- 2. GROUNDING** - The Model MC-612 must be **properly grounded** to regulate accurately. The two ground wires located in the harness must be securely attached to their terminals and at the alternator's preferred ground to ensure proper grounding. A grounding cable between the alternator and the system ground is strongly recommended.
- 3. VOLTAGE READINGS** - MC-612 digital circuitry is engineered to monitor battery charge state and automatically compensate for changes in battery voltage during operation. As a result, it is NOT unusual to see near-constant changes in the regulator's Battery Voltage display. These voltage changes reflect the regulator's ability to make precise corrections to optimize charging efficiency based on changes in system loads.
- 5. ELECTRICAL TACHOMETERS** - Many factory and aftermarket tachometers require an AC pulse from the alternator to drive the tachometer. If you are using an electrical tachometer that is being driven off of your alternator's stator pulse, plug the white stator wire into the terminal provided on the regulator, and the tach feed into the Tach Out terminal. If you are not using the stator pulse to drive your tachometer, **DO NOT** plug the stator wire into the regulator's Stator connection.

When using the alternator and regulator to drive your tachometer, there is a possibility that you will see surface voltage creeping in excess of target voltage when batteries are fully charged and there is no load on the system. This occurs as a result of the regulator's effort to provide just enough voltage to keep the tachometer feed activated. This voltage creep can usually be reduced or eliminated by increasing the load on the batteries, ie., turning on a few cabin lights or cabin fans, until the batteries are allowed to accept charging voltage.

- 4. DUAL-OUTPUT OPERATION** - When using the MC-612 with a dual-output alternator it is essential that the regulator senses the largest battery bank. The positive Battery sense wire must be attached to the alternator output terminal connected to the larger battery bank or at the larger bank. If your system includes a large house battery and a smaller starting battery, there is the possibility that the smaller battery may see excess surface voltage during charging.
- 5. ALTERNATOR & BATTERY TEMPERATURE SENSORS (optional)** - Alternator Temperature Sensor monitors for over-temperature conditions at the alternator. If alternator temperatures outside of safe limits are detected, the regulator will reduce alternator output to 50% and will activate an alarm circuit. **NOTE:** This option is not intended to be used as part of regular operation. If circuit is activated, inspect and repair the system immediately. Optional Battery temperature sensing compensates for above- or below-normal battery temperatures by automatically adjusting charging voltage. It is not unusual to see charging voltage rise safely above normal levels when battery temperatures are below 26°C or drop when temperatures exceed 26°C.
- 6. MAGNETIC REED SWITCH** - Not all magnets are alike. You may find that one magnet will activate the reed switch with little effort, while another similar magnet may require a bit of maneuvering to find the switch's "sweet spot." If you have difficulty adjusting program modes, be sure to check for the dot at the top of the LED between the second and third display digits to ensure that you are activating the switch.

#### LIMITED PRODUCT WARRANTY

BALMAR warrants to the original consumer/purchaser the product is free from any defects in material or workmanship for a period of one year from the date of purchase. If any such defect is discovered within the warranty period, BALMAR will replace the regulator free of charge, subject to verification of the defect or malfunction upon delivery or shipping prepaid to BALMAR.

This warranty DOES NOT apply to defects or physical damage resulting from abuse, neglect, accident, improper repair, alteration, modification, or unreasonable use of the products resulting in breakdown, cracked or broken cases nor are parts damaged by fire, water, freezing, collision, theft, explosion, rust, corrosion or items damaged in shipment in route to BALMAR for repair. BALMAR assumes no responsibility for consequential damage or loss or expense arising from these products or any labor required for service or repair.

BALMAR WILL NOT repair or be held responsible for any product sent without proper identification and return address or RA number clearly marked on the package. You must include proof of date and place of purchase (photocopy of purchase invoice) or we cannot be responsible for repairs or replacement. In order to expedite warranty claims more efficiently, BALMAR asks that prior to returning a defective product for repair, you call their customer service department for a warranty return authorization number.

If factory service is required, you can contact our BALMAR Customer Service Department Monday through Thursday, 7:30 AM to 5:30 PM, (PST) 1-360 435-6100 ext "3".

Material required for the repair or replacement for the defective part or product is to be supplied free of charge upon delivery of the defective regulator to BALMAR, 19009 61st Ave. NE, Arlington, WA 98223. Customer is responsible for all return transportation charges and any air or rush delivery expense. BALMAR reserves the right to determine whether to repair or replace defective components.

THE ABOVE LIMITATIONS MAY NOT APPLY TO YOU. SOME STATES DO NOT ALLOW LIMITATIONS ON HOW LONG AN IMPLIED WARRANTY LASTS. NO PERSON, AGENT, DEALER IS AUTHORIZED TO GIVE ANY WARRANTY.

**BALMAR** 19009 61st Ave. NE, Arlington, WA 98223 Phone: (360) 435-6100, Fax: (360) 435-3210  
E-mail: [balmar@balmar.net](mailto:balmar@balmar.net), Web: [www.balmar.net](http://www.balmar.net)

## IV. REGULATOR INSTALLATION

1. Mount the regulator in a dry, well-ventilated location, away from hoses and exhaust manifolds which may cause damage to the regulator or wiring. Avoid areas of heat and/or high vibration. **Strain relief should be added at the alternator end of the harness to minimize risk of wire damage.**
2. The **RED** wire (in the harness) powers the regulator. Attach at the positive output terminal at the back of the alternator. If an isolator is used, this wire must be located on the battery side of the isolator. **THIS WIRE MUST BE PROTECTED BY A 10-AMP FUSE** (included in the wiring harness).
3. The **POSITIVE** battery sense wire monitors battery voltage. The positive and negative sense wires **MUST** be connected for the regulator to work. The positive sense wire may be connected 1) at the positive output terminal of the alternator, at the positive post of the battery (if single bank system) or at the "common" terminal of the battery selector switch; or 2) on the isolator terminal for the largest battery bank (only if isolator is used). This wire is user supplied and should be 16-gauge (minimum). Spade and ring terminals, and a 1-A mini fuse pigtail are provided. **FUSING IS REQUIRED.** Refer to regulator side label, or Figure 3 below for terminal locations. **Caution: Sense wires MUST always see the battery being charged.** Be sure to observe polarity when connecting. When connected, the Positive Battery Sense draws approximately .053mA. **Note: System voltage must exceed 11.0 VDC for regulator to operate.**
4. The **BROWN** (ignition) wire activates the regulator when +12VDC is applied to the system. Attach the BROWN wire to a switched +12VDC source. The auxiliary side of the ignition switch, or an independent (ungrounded) oil pressure switch are both acceptable connection points. A toggle switch may be added to this circuit to shut down the alternator load in cases where maximum propulsion is needed.
5. Attach the 4-conductor harness plug to the regulator (see illustration). The second **BLACK** (ground) wire in the harness attaches to the Secondary Ground Terminal. Both **BLACK** wires attach to preferred ground terminal on the alternator. A (user supplied) ground strap between the alternator and the system ground at the engine is also strongly recommended.
6. Connect **BLUE** (field) and **WHITE** (stator) wires to plug or ring terminal connectors at alternator. May vary by alternator type.
7. If you are using an electrical tachometer that is being driven off of your alternator's stator pulse, plug the **WHITE** stator wire into the terminal provided on the regulator, and the tach feed into the Tach Out terminal. If you are not using the stator pulse to drive your tachometer, **DO NOT** plug the stator wire into the regulator's Stator connection, as the attachment of the stator wire to the regulator tells the regulator that it is necessary to continue to provide a voltage pulse to maintain a tach signal, even if the batteries are fully charged.

When using the alternator and regulator to drive your tachometer, there is a possibility that you will see system voltage creeping up when your batteries are fully charged. This occurs as a result of the regulator's effort to provide a "blip" of voltage to the alternator to keep the tachometer feed activated. This voltage creep can usually be reduced or eliminated by applying a load to the batteries.

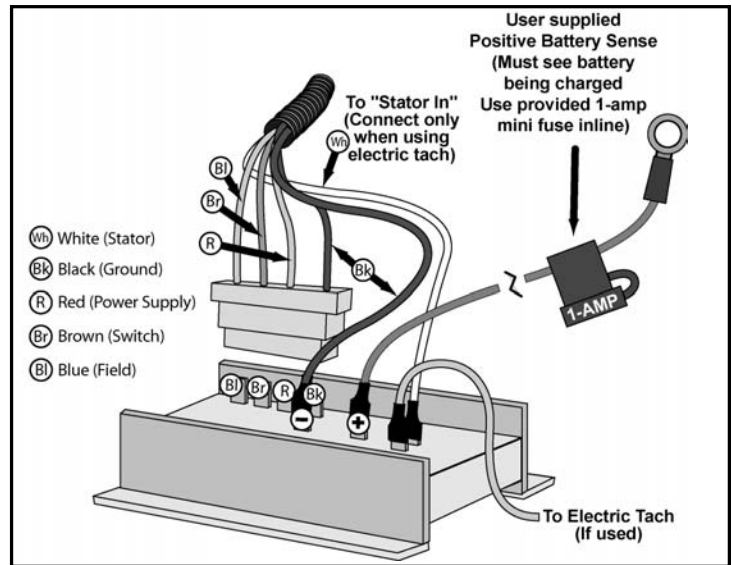

Figure 1 - Regulator wiring attachment.

Length Amps	10 Ft.	15 Ft.	20 Ft.	25 Ft.	50 Ft.	75 Ft.	100 Ft.
25	10	8	8	6	4	2	1
50	8	6	4	4	1	2/0	3/0
75	6	4	2	2	2/0	3/0	4/0
100	4	2	2	1	3/0	4/0	
125	4	2	1	1/0	3/0	4/0	
150	2	1	1/0	2/0	4/0		
175	2	1/0	2/0	3/0			
200	2	1/0	2/0	3/0			
225	1	2/0	3/0	4/0			
250	1	2/0	3/0	4/0			
275	1/0	2/0	4/0				
300	1/0	3/0	4/0				
325	1/0	3/0	4/0				
350	2/0	3/0					
375	2/0	4/0					

Figure 2 - Cable size chart. Represents 3% voltage drop. Lengths should be measured in round trip. Undersizing output cable can result in.

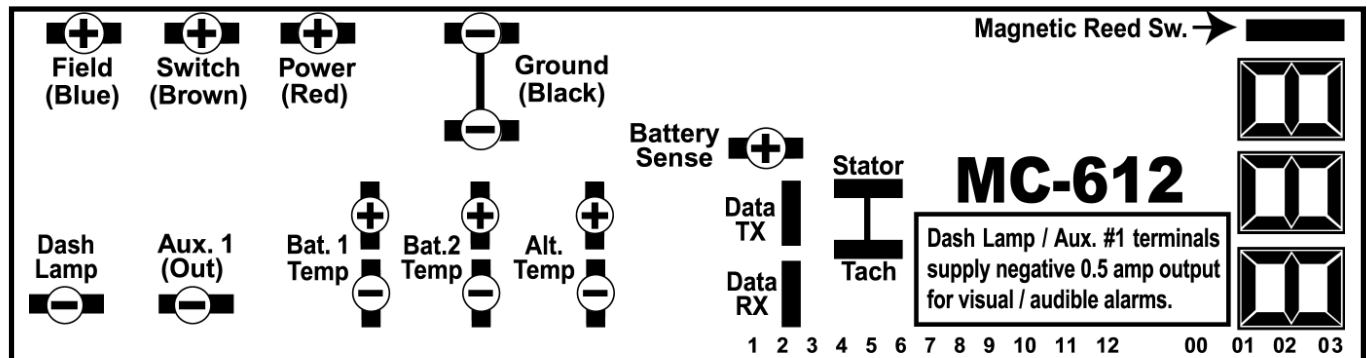

Figure 3 - Regulator terminal layout.

## V. ALARM AND SENSOR INSTALLATION

### Alternator Temperature Sensor (MC-TS-A) - Optional

The Alternator Temperature Sensor enables the regulator to sense when alternator temperature exceeds safe limits. The MC-612 responds by reducing the field current at the alternator and activating the alarm output. To install the Alternator Temperature Sensor:

1. Attach the positive and negative wires to the Alternator Temperature Sensor terminals on the MC-612 (See Figure 4). Observe proper polarity at the terminals.
2. Attach the heavy lug terminal to a location described below on your alternator. Flat washers are included with the temperature sensors to ensure solid mounting connections. The following are typical installation locations:  
MID CASE MOUNT - Small Case Alternator - Remove (1) of (4) 5/32" Allen bolts, install probe, re-secure bolt. (See Figure 5.)  
MID CASE MOUNT - Large Case Alternator - Remove (1) of (4) 3/16" Allen bolts, install probe, re-secure bolt.

**Caution:** The alternator temperature sensor is not intended as a method to maintain alternator temperature. Optional temperature sensors are not a guarantee of protection against damage from overheat conditions. Inspect your system as quickly as possible if the sensor alarm is activated.

### Battery Temperature Sensor (MC-TS-B) - Optional

When equipped with an optional Battery Temperature Sensor, the MC-612 will automatically compensate for variation above and below normal temperatures.

The MC-612 is equipped with dual battery sensors to enable sensing at two separate batteries. To ensure proper operation, be sure the battery terminals are completely clean and free of corrosion prior to installation. To install the Battery Temperature Sensor:

1. Secure the 3/8" copper probe to a clean negative (-) battery terminal (see Figure 6). The 20' leads may be shortened or extended, if needed. Note: An improperly installed or corroded battery terminal may generate heat and severely diminish charging and impede accurate temperature sensing.
2. While observing polarity, connect the battery temperature pins to the positive and negative terminals as shown on Figure 4.

**Note:** Battery #1 terminal is capable of temperature compensation and activating warning alarm. Battery #2 terminal activates the warning alarm only. The upper voltage limit for battery temp compensation is 14.8 volts. If higher limits are desired, adjust voltage levels in the Compensation Limit (CL) mode of the advanced programming adjustments.

### Lamp / Alarm Outputs

Two output terminals, one for system alarms (dash lamp) and another for advisory information (Aux. #1), are included. These terminals output battery negative (0.5-amp max) when in alarm condition. Refer to Figure 7 for common system conditions that may initiate an alarm. When in the alarm mode, the 3-digit numeric display will indicate the exact cause for the alarm in Long Display. Specific advisory codes are shown in Figure 17.

### Small Engine Mode

The MC-612 can be switched to provide a half-power setting by installing a toggle switch between the positive and negative terminals of the alternator temperature sensor circuit. When activated by closing the switch, the regulator reduces the alternator output by a maximum 50%. This mode is ideal for smaller engines that are not capable of providing suitable horsepower to drive both the alternator and propeller at full output. When in Small Engine Mode, the regulator will send a signal to the Auxiliary #1 Status Output.

## VI. BASIC PROGRAMMING

The Model MC-612 provides a wide range of operational, programming and diagnostic data through its 3-digit numeric LED readout. After an initial start-up period, the numeric LED will cycle through the Short Display, shown in Figure 8 on the following page. The short display includes manufacturer, model, battery type, charging cycle, actual voltage and target voltage. This display cycles continuously during regulator operation.

In addition to its Universal (default) factory program, which can be used safely with most battery types, the MC-612 features programs for: gel, standard lead acid, deep-cycle lead acid, AGM (absorbed glass mat), Optima (spiral), as well as voltage-sensitive (halogen) applications.



Figure 4 - Proper attachment of optional battery and alternator temp sensors at the regulator.

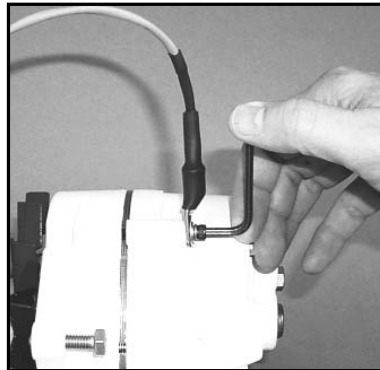

Figure 5 - Mounting temp sensor mid-case on small case alternator.



Figure 6 - Mounting temperature sensor on battery negative terminal post.

## ALARM OUTPUT FUNCTIONS

### Alarm Output (Dash Lamp)

(-) 0.5 amp - when in alarm mode

- Low battery voltage (030)
- High battery voltage (040)
- High temperature at battery #1 (020)
- High temperature at battery #2 (021)
- High temperature at alternator (022)

### Aux. #1 (Advisory) Output

(-) 0.5 amp - when in alarm mode

- Alt. output at full capacity
- Small engine option activated (051)
- Equalization mode activated

Figure 7 - Dash Lamp and Aux. #1 advisory output functions.

The MC-612 is equipped with a magnetic reed switch, embedded in the epoxy potting, which activates the regulator's programming. The switch works in two specific actions, described in the shaded box below:

**'ACTIVATE-RELEASE'** Refers to the activation and immediate deactivation of the switch by lowering the magnetic programming tool onto the upper corner of the switch, and immediately deactivating the switch by removing the magnet from the switch. An LED dot between the second and third digits on the display will indicate switch activation.

**'ACTIVATE-HOLD ... RELEASE'** Typically used during programming, this action requires holding the magnet to the switch until desired values are shown on the display. Once the desired setting is reached, the magnet is removed to deactivate the switch.

**Note:** Program function will alternately cycle up or down each time the programming mode is activated. If you miss your desired program value, release the switch, wait for the program mode display (eg., PRO), and re-activate the switch. The direction of scroll will reverse. Any advanced programming values will be retained within the regulator's memory until the preset battery programming is reset.

To set the regulator for your desired battery program:

1. 'ACTIVATE-HOLD' the switch. The display will show the "Pro" mode, indicating that the Program mode has been activated.
2. 'HOLD' while the display scrolls, until the numeric equivalent to your battery type is displayed on the LED screen. See Figure 10 to determine which selectable preset program is most desirable for your battery technology. Figure 11 provides detailed information regarding preset programs.
3. 'RELEASE' when the desired value is attained.
4. Once a value has been chosen, the display will return to the "Pro" mode. At this point, you can adjust, up or down, by repeating Steps 1 through 3 until your desired program is selected.

If no changes are made, the program you have selected will be locked into permanent memory until modified. The "SAV" code will be displayed, indicating the program has been locked into memory.

### Charging Stages

The MC-612 uses up to 12 individual stages to ensure proper charging. Each stage may contain a specific voltage or time value, or a combination of values. These stages are displayed in both Short and Long Display modes, and are described in Figure 12.

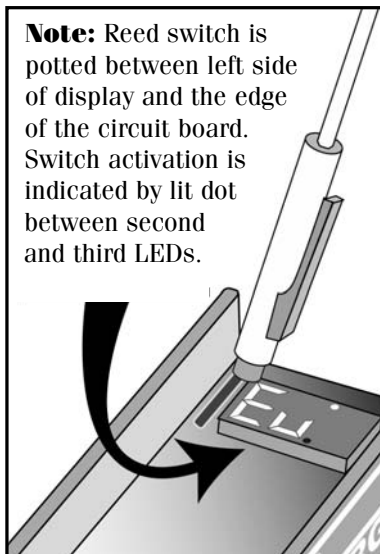

**Figure 9** - Location of magnetic reed switch. Long display, preset programming and advanced programming are accessed by activating switch.

<b>Mode 1</b> - Manufacturer ID. Readout displays "BAL"	8AL
<b>Mode 2</b> - Regulator model ID. Readout displays "612"	612
<b>Mode 3</b> - Preset program number. Corresponds to codes described in Figure 10.	PRO
<b>Mode 4</b> - Battery type. Corresponds to codes described in Figure 10	UFP
<b>Mode 5</b> - Stage of charge. Corresponds to codes described in Figure 12.	503
<b>Mode 6</b> - Battery voltage. Precedes numeric readout of real-time voltage at regulator.	8.4
<b>Mode 7</b> - Battery voltage. Indicates battery voltage seen by the regulator. In tenths.	13.1
<b>Mode 8</b> - Calculated voltage. Precedes numeric readout of target charging voltage.	14.1
<b>Mode 9</b> - Calculated voltage. Shows target voltage based on charging stage. In tenths.	14.1

**Figure 8** - Normal (short) display.

<b>Program 1</b> - Universal Factory program. Safe for most battery types	UFP
<b>Program 2</b> - Flooded Deep Cycle program. Thick plate lead acid technology.	Fdc
<b>Program 3</b> - Gel program. For gelled electrolyte technology.	6EL
<b>Program 4</b> - AGM program. For absorbed glass mat battery technology.	AGL
<b>Program 5</b> - Optima program. For spiral wound Optima battery technology.	OPS
<b>Program 6</b> - Standard flooded program. For starting type flooded batteries.	F56
<b>Program 7</b> - Halogen program. For voltage-sensitive electrical applications.	HAL

**Figure 10** - Preset program codes.

Primary Program Settings	PRG-1 Universal Factory Program	PRG-2 Deep Cycle Flooded Lead Acid	PRG-3 Gel Cell	PRG-4 Absorbed Glass Mat (AGM)	PRG-5 Optima Spiral Wound	PRG-6 Standard Flooded Lead Acid	PRG-7 Halogen Voltage Sensitive
<b>Mode</b>							
<b>Start Delay (Seconds)</b>	45	45	45	45	45	45	45
<b>Ramp Up (Seconds)</b>	60	60	60	60	60	60	60
<b>Bulk Voltage (Max)</b>	14.10	14.60	14.10	14.38	14.60	14.40	14.00
<b>Bulk Time (Minimum)</b>	36 min.	36 min.	36 min.	36 min.	36 min.	36 min.	36 min.
<b>Absorption Voltage</b>	13.90	14.40	13.90	14.18	14.40	14.20	13.80
<b>Absorption Time (Minimum)</b>	36 min.	36 min.	36 min.	36 min.	36 min.	36 min.	36 min.
<b>Float Voltage</b>	13.42	13.35	13.70	13.38	13.40	13.40	13.50
<b>Float Time (Maximum)</b>	6 hr.	6 hr.	6 hr.	6 hr.	6 hr.	6 hr.	6 hr.
<b>High Voltage Alarm</b>	15.20	15.60	15.10	15.38	15.60	15.40	15.00
<b>Low Voltage Alarm</b>	12.80	12.80	12.80	12.80	12.80	12.80	12.80
<b>Max Battery Temperature</b>	125F/52C	125F/52C	125F/52C	125F/52C	125F/52C	125F/52C	125F/52C
<b>Max Alternator Temperature</b>	225F/107C	225F/107C	225F/107C	225F/107C	225F/107C	225F/107C	225F/107C
<b>Equalization (User Prog.)</b>	Yes	Yes	No	Yes	No	Yes	No

**Figure 11** - Preset program values. Voltages shown may vary by +/- 3% from values shown. **Caution:** Some battery technologies may be damaged by equalization voltage. Contact your battery manufacturer for specific requirements regarding equalization.

## Long Display

To access the Long Display, **activate-release** switch with the magnetic programming tool while the Short Display is cycling. The numeric LED return to the beginning of the cycle. The long display will begin with the same elements shown in Figure 8. Additional information, as detailed in Figure 13, will follow.

The display will scroll through the long program once, before returning to the short display.

## Advisory Codes

Descriptions for these codes can be found in Figure 14. To reset advisory codes, access the Advanced Programming mode as described at the beginning of Section VIII. AP mode will cycle three times and return to normal mode. Codes will automatically reset when AP mode is complete.

## VII. ADVANCED PROGRAMMING

Advanced programming (AP) provides user-adjustable program customization. Any changes in AP will be based on the previously-set battery program. Resetting the basic battery program will automatically clear any advanced programming settings. To access:

1. With regulator in Long Display mode, **ACTIVATE-HOLD** until the "Pr" display code appears. **RELEASE**. The "PrA" display code will appear.

(**CAUTION:** If the switch is held too long, the regulator will return to the preset program adjustment mode). Once in advanced program mode, the display will cycle through the various advanced programming modes (see Figure 15). *Advanced Programming mode will cycle three times before returning to standard operating mode.*

### Start Delay - PrA Mode 2

The 45-second delay prior to charging can be increased or decreased in duration. To adjust:

1. **ACTIVATE-HOLD** switch when "DLc" is highlighted on the Advanced programming display. Beginning at "45" the display will begin to increase in one-second increments. **RELEASE** when desired time is shown.
2. To change direction of scroll, **ACTIVATE-HOLD** until values begin to rise. **RELEASE** and wait for "DLc" display. **RE-ACTIVATE** and **HOLD** until desired value is met. **RELEASE**.

### Compensation Limit - PrA Mode 3

When equipped with optional Battery Temperature Sensor, the MC-612 will automatically adjust charging voltage to compensate for battery temperature.

In default mode, the regulator is limited to maximum compensated voltage of 14.8 volts to minimize the likelihood of over-voltage conditions.

Compensation Limit allows the user to advance or decrease maximum compensated voltage to suit specific charging system needs.

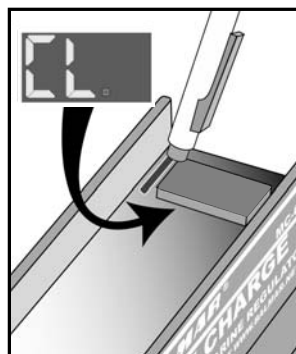

Figure 16 - Indicates Compensation Limit mode.

<b>Stage 1</b> - Start Delay. Provides a 45-second delay before applying load on engine/belts.	501	<b>Stage 7</b> - Calc. absorption. Maintains voltage at bulk level until target goals are met.	507
<b>Stage 2</b> - Soft Ramp. Slowly increases charging voltage, minimizing belt slippage.	502	<b>Stage 8</b> - Ramp down to float. Transition from absorption to float. Non adjustable.	508
<b>Stage 3</b> - Bulk Charge. Holds voltage at preset bulk level for minimum time period.	503	<b>Stage 9</b> - Float charge. Maintains voltage at float level for minimum time period.	509
<b>Stage 4</b> - Calculated bulk. Maintains voltage at bulk level until target goals are met.	504	<b>Stage 10</b> - Calc. float. Holds voltage at float level until target goals are met.	510
<b>Stage 5</b> - Ramp to absorption. Transition from bulk to absorption. Non adjustable.	505	<b>Stage 11</b> - Ramp to equalization. Batteries should be fully charged prior to EQ.	511
<b>Stage 6</b> - Absorption charge. Holds voltage at preset bulk level for minimum time period.	506	<b>Stage 12</b> - Equalization. See battery mfg. for time and voltage requirements.	512

Figure 12 - Charge stage codes as seen in Long Display.

<b>Revision #</b> - Indicates version of software code.	50	<b>A-Value</b> - Factory use only.	845	<b>FBA</b> - Indicates low field threshold required to ramp from bulk to absorption.	FbA
<b>Battery #1 Temp</b> - Indicates ambient temperature at primary battery bank.	81	<b>Field Percentage</b> - Indicates real-time field value. Reading of 60 indicates 100% field.	526	<b>FBA (2)</b> - Shows low field threshold. See FBA details in Advanced Programming.	190
<b>Battery #1 Temp (2)</b> - Numeric readout of ambient battery temp. Reads in	26c	<b>Run-Time</b> - Details number of hours regulator has operated.	4r	<b>FFL</b> - Indicates low field threshold required to ramp from absorption to float.	FfL
<b>Battery #2 Temp</b> - Indicates ambient temperature at secondary battery bank.	82	<b>Run-Time (2)</b> - Shows time in tenths of hours, up to 99.9 hours.	028	<b>FFL (2)</b> - Shows low field threshold. See FFL details in Advanced Programming.	190
<b>Battery #2 Temp (2)</b> - Readout of ambient battery temp. Reads in celsius.	26c	<b>Run-Time (3)</b> - Shows length of operation in excess of 99.9 hours.	000	<b>Advisory Codes</b> - Diagnostic & info codes for regulator. See descriptions below.	800

Figure 13 - Long Display (LD) attributes as displayed on digital numeric readout.

<b>CODE 001</b> - Factory use only.	<b>CODE 022</b> - Alternator exceeding recommended temperature limits.
<b>CODE 002</b> - Factory use only.	<b>CODE 024</b> - Factory use only.
<b>CODE 010</b> - Wire short at battery #1 temperature sensing terminal.	<b>CODE 030</b> - Voltage too low at battery.
<b>CODE 011</b> - Sensor wire not found at battery #1 temperature sensing terminal.	<b>CODE 031</b> - Factory use only.
<b>CODE 012</b> - Wire short at battery #2 temperature sensing terminal.	<b>CODE 032</b> - Factory use only.
<b>CODE 013</b> - Sensor wire not found at battery #2 temperature sensing terminal.	<b>CODE 040</b> - Voltage too high at battery.
<b>CODE 014</b> - Wire short at alternator temperature sensor terminal.	<b>CODE 041</b> - Factory use only.
<b>CODE 015</b> - Sensor wire not found at alternator temperature sensor terminal.	<b>CODE 042</b> - Factory use only.
<b>CODE 020</b> - Battery #1 exceeding recommended temperature limits.	<b>CODE 050</b> - Open field.
<b>CODE 021</b> - Battery #2 exceeding recommended temperature limits.	<b>CODE 051*</b> - Small Engine Mode activated.
	<b>CODE 052*</b> - Amp manager is in operation.

*Underlined codes represent those pertaining to Alarm Output (dash lamp) operation. Codes highlighted by an asterisk (\*) pertain to Aux. #1 advisory output.*

Figure 14 - Advisory/diagnostic codes.

<b>PrA Mode 1</b> - Indicates entry into advanced program mode.	PrA	<b>PrA Mode 8</b> - Float voltage "Fv". Adjusts up or down in tenths of a volt.	Fv
<b>PrA Mode 2</b> - Start delay "DLc" adjustment. Shown in seconds. Adjusts up or down.	DLc	<b>PrA Mode 9</b> - Float time "F1c". Adjusts up or down in tenths of an hour.	F1c
<b>PrA Mode 3</b> - Compensation limit "CL". Adjustable upper voltage limit. Preset is 14.8V.	CL	<b>PrA Mode 10</b> - Amp Manager "AP". User adjustable. See details on following page.	AP
<b>PrA Mode 4</b> - Bulk voltage "Bv". Adjusts up or down in tenths of a volt.	Bv	<b>PrA Mode 11</b> - Equalization voltage "Ev". Adjusts up or down in tenths of a volt.	Ev
<b>PrA Mode 5</b> - Bulk time "B1c". Adjusts up or down in tenths of an hour.	B1c	<b>PrA Mode 12</b> - Equalization time "E1c". Adjusts up or down in tenths of an hour.	E1c
<b>PrA Mode 6</b> - Absorption voltage "Av". Adjusts up or down in tenths of a volt.	Av	<b>PrA Mode 13</b> - Field bulk to absorption "FbA". See details in Advanced Programming text.	FbA
<b>PrA Mode 7</b> - Absorption time "A1c". Adjusts up or down in tenths of an hour.	A1c	<b>PrA Mode 14</b> - Field to float. "FFL". See details in Advanced Programming text.	FfL

Figure 15 - Advanced Programming (PrA).

## Compensation Limit (Continued)

To adjust voltage compensation limits:

1. **ACTIVATE-HOLD** switch when "CL" is displayed (see Figure 16). Value 14.8 will be highlighted. Display will scroll upward. **RELEASE** when desired value is shown.
2. To reduce compensated voltage limit, **ACTIVATE-HOLD** until voltage limit value is displayed. **RELEASE**. When "CL" is again displayed, **RE-ACTIVATE** and **HOLD**. Regulator display will scroll in opposite direction. **RELEASE** when desired value is reached.

## Advanced Voltage Adjustment (Bulk, Absorption, Float) - PrA Modes 4, 6 & 8

User adjustment of charging voltage above or below preset levels is possible in PrA modes 4, 6, and 8. To adjust voltages in bulk, absorption or float stages:

1. **ACTIVATE-HOLD** switch when the desired code is displayed (see Figure 17. Bv=bulk, Av=absorption, or Fv=float voltage). Standard preset program voltage will be highlighted. Display will scroll upward. **RELEASE** when desired value is shown.
2. To reduce voltage, **ACTIVATE-HOLD** until voltage values begin to climb. **RELEASE**. When voltage mode is re-highlighted (eg., BV), **RE-ACTIVATE** and **HOLD**. Voltage values will scroll in opposite direction. **RELEASE** when desired value is reached.

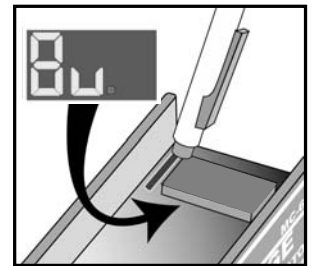

Figure 17 - Voltage adjustment. Bulk Voltage shown.

## Advanced Minimum Time Adjustment (Bulk, Absorption, Float) - PrA Modes 5, 7 & 9

Minimum charging time above or below preset levels is adjustable in PrA modes 5, 7, and 9. *Adjustments are in tenths of an hour.* To adjust minimum times in bulk, absorption or float stages:

1. **ACTIVATE-HOLD** switch when the desired code is displayed (see Figure 18. B1c=bulk, A1c=absorption, and F1c=float time). Standard preset program times will be highlighted. Display will scroll upward. **RELEASE** when desired value is shown.
2. To reduce minimum time, **ACTIVATE-HOLD** until time values begin to climb. **RELEASE**. When programming mode is re-highlighted (eg., B1c), **RE-ACTIVATE** and **HOLD**. Minimum time values will scroll in opposite direction. **RELEASE** when desired value is reached.

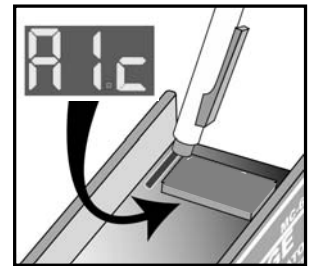

Figure 18 - Time adjustment. Absorption time shown.

## Amp Manager (AP) - PrA Mode 10

The Amp Manager function enables you to reduce the alternator output by limiting alternator field. This feature can be used as a method to minimize alternator overheating when alternator is undersized to the battery bank, as well as minimizing difficulties with chronic belt slippage. Amp Manager adjustments are made in 2% increments. To adjust Amp Manager values:

1. **ACTIVATE-HOLD** when display cycles to "AP" (See Figure 19. PrA Mode 09). "AP" will be followed by "OFF" code. **RELEASE**.
2. **ACTIVATE-HOLD** "OFF" display cycles to "249". The value "249" represents full field output. The numeric value on the display will decrease until you **RELEASE**. To reverse direction of scroll, **RE-ACTIVATE** and **HOLD** when "AP" appears. **RELEASE** when desired value is reached.

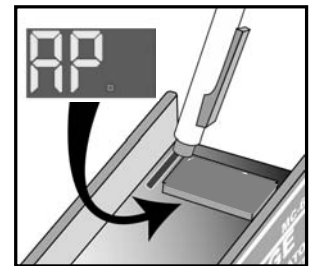

Figure 19 - Amp Manager mode.

**Note:** The value "185" represents approximately 75% field output, "125" represents approximately 50% field output, and "65" represents approximately 25% field output.

## Equalization Mode (EQ) - PrA Modes 11 & 12

Allows increase in charging voltage to minimize battery sulfation. (Equalization is **ONLY** suggested for batteries noted as "equalization friendly" in Figure 11 on Page 4). Consult your battery manufacturer for equalization time and voltage recommendations. Equalization must be initiated through the advanced programming. It is **NOT** a standard mode of operation. Once equalization voltage and time values are saved into the regulator's programming, the equalization process will start immediately. Once equalization has occurred, the regulator will revert to its preset program status. The user will need to re-activate equalization mode for subsequent equalizations. For system safety, equalization voltage is limited to 15.8 volts. **NOTE: BOTH EQUALIZATION TIME AND VOLTAGE MUST BE SET TO INITIATE CHARGE.**

To adjust equalization voltage (PrA Mode 11):

1. 'ACTIVATE-RELEASE' "PrA" display cycles to "Ev" followed by "OFF" code.
2. 'ACTIVATE-HOLD'. "OFF" display cycles to numeric voltage values. When the manufacturer-recommended voltage is reached, **RELEASE**.

To adjust equalization time (PrA Mode 12):

1. 'ACTIVATE-RELEASE' "PrA". Display cycles to "Ec" followed by "OFF" code.
2. 'ACTIVATE-HOLD'. "OFF" display cycles to numeric equalization time values. When the manufacturer-recommended time value is reached, 'RELEASE'.

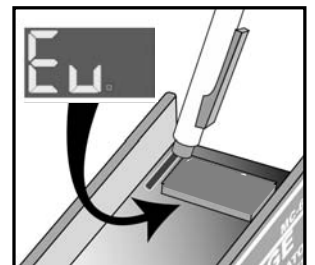

Figure 20 - EQ voltage mode.

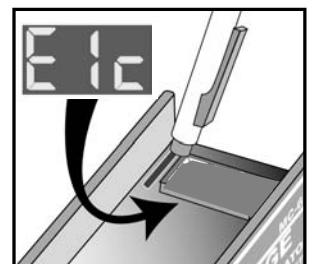

Figure 21 - EQ time mode.

## Field Threshold Control (FbA & FFL) - PrA Mode 13 & 14

The regulator utilizes a number of factors when determining when to change between charging stages. A primary factor considered is the amount of energy the alternator is having to expel to meet battery loads. This alternator workload can be determined by monitoring the percentage of field current the regulator is applying to the alternator. When determining when to change from Bulk to Absorption stage, and then from Absorption to Float stage, the regulator looks to see how hard the alternator is working. In preset programming, target field voltage under 75% is considered the standard threshold for advancement to the next charging stage (among other factors).

In applications where the alternator is oversized for the battery load, it may be necessary to reduce the threshold below the standard 75% to ensure that the batteries continue to charge efficiently. Inversely, if an alternator is undersized for the battery load, the threshold can be raised to reduce undue load on the alternator. Two user adjustments are provided in Advanced Programming mode -- Field Bulk to Absorption (FbA) and Field Float (FFL). Directions for adjustment are applicable to either mode of adjustment. To adjust:

1. **ACTIVATE-HOLD** when display cycles to FbA (Bulk) or FFL (Float) (See Figures 22 & 23. PrA Modes 13 & 14). Value of "220" will be displayed. Values will scroll downward. **RELEASE** when desired value is reached.
2. To reverse the direction of scroll, **RE-ACTIVATE** and **HOLD** when the FbA or FFL codes are highlighted. **RELEASE** when desired value is reached.

**Note:** The value "220" represents approximately 165% field output, "110" represents approximately 50% field output, and "55" represents approximately 25% field output.

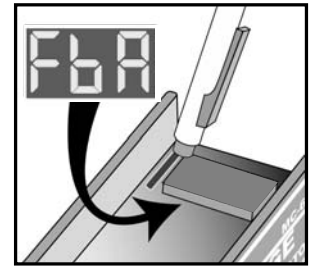

Figure 22 - Field Threshold adjustment. Bulk to Absorption display is shown.

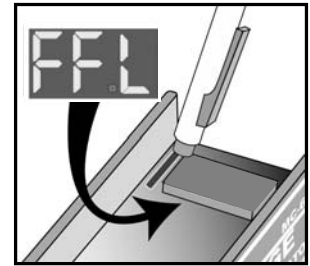

Figure 22 - Field Threshold adjustment. Field to Float display is shown.

## VIII. SYSTEM TROUBLESHOOTING

The majority of charging difficulties can be attributed to damage, corrosion or wear at wires or wiring connections. Before attempting to troubleshoot potential alternator or regulator issues, be sure to address the following:

1. REMOVE AND CLEAN all charging system electrical connections (positive and negative). Check the voltage regulator's harness for resistance. Wires and terminals can and will become corroded and need to be cleaned or replaced.
2. CHARGE ALL BATTERIES to their proper fully charged state and determine if they are serviceable. If your batteries are flooded-type, use your hydrometer to determine their condition.
3. CHECK AND TIGHTEN alternator belt. If the belt show signs of wear or damage, now is an ideal time for replacement. Always replace existing belts with the finest quality replacements available.

After determining that your batteries and wiring are in suitable condition, use the following tests to determine if charging problems are a result of a faulty alternator or regulator. The following tests provide an opportunity to isolate the alternator, regulator and wiring harness in order to determine which component may be malfunctioning. In order to perform these tests, you will need an independent multimeter (preferably a digital type). In an emergency, a 12V light bulb or test light can be used to help determine if power or working grounds exist. An amp meter and a battery hydrometer with a thermometer are also helpful diagnostic tools.

### Voltage Regulator Test

After inspecting and repairing wires and connections, belts and batteries, set your voltmeter to 12V and connect the voltmeter's negative lead to the BLACK ground wire at the regulator (see Figure 23),

1. With the ignition OFF, check voltage on the RED (sensing), BLUE (field) and BROWN (ignition) wires in the regulator plug.
2. With the ignition in the ON position (engine not running), check for voltage on the RED (sensing), BLUE (field) and BROWN (ignition) wires. The voltmeter should read:
3. With the ignition in the ON position (with engine running at 1,400 rpm fast idle), check for voltage on the RED (sensing), BLUE (field) and BROWN (ignition) wires in the regulator plug.

Compare your readings with the table at right. If readings on RED or BROWN wires do not match values shown, check 10-amp and 1-amp fuses, wiring and connections back to their sources. If RED and BROWN match expected readings, but BLUE does not, unplug and re-plug four-prong plug and re-test. If the BLUE wire shows zero voltage and the display is not lit, check connections and fusing on the Positive Battery Sense wire. Check voltage at the base of the Positive Battery Sense terminal with your test meter.

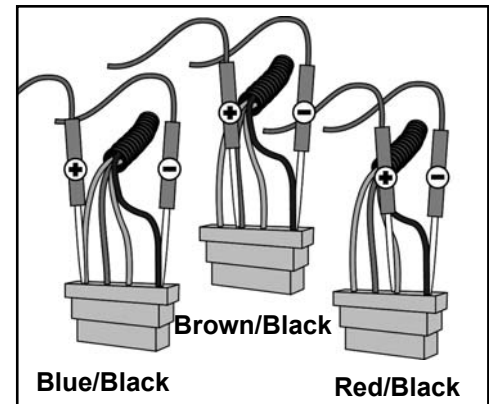

Figure 23 - Inserting voltmeter probes.

Expected Actual	Engine Off	Ignition On	Engine Run
Red Wire	12V*	12V*	12-14V**
Brown Wire	0V*	12V***	12-14V**
Blue Wire	0V*	8-11V**	3-10V**

\* 11.5 - 12.8 VDC battery voltage at rest (no charging occurring). If your batteries are isolated and your RED (sensing) wire shows voltages other than those shown above, make sure that the wire is connected on the "battery" side of the isolator. The red wire must "see" the battery directly.

\*\* 13.5 - 14.5 VDC battery voltage when charging.

\*\*\* Voltage may be zero with Ignition On/Engine Off if brown wire is connected to an oil pressure switch.



## REGULATOR VOLTAGE TEST (CONTINUED)

If voltage is not present on the RED, the BROWN and the Positive Battery Sense Wire, the regulator will not work. If voltage is as expected at the RED the BROWN and Positive Battery Sense wire, and there is zero, or an unexpected voltage reading at the BLUE wire, contact our technical support staff at (360) 435-6100, or e-mail us at balmar@balmar.net.

If all voltages at the regulator meet expectations, yet the alternator is not producing charging current, we will want to test the alternator. The following describes the recommended methods for determining alternator functionality.

## ALTERNATOR TESTING

**Test A** - The alternator and regulator can be tested for function by determining if a magnetic field exists at the alternator's pulley shaft or rear bearing. To test:

1. With the ignition in the OFF position, place the head of a steel screwdriver near the nut on the pulley shaft or near the rear bearing of the alternator. There should be no evidence of a magnetic field pulling the screwdriver toward the alternator.
2. Engage the ignition, **WITHOUT** starting the engine, to activate the voltage regulator. If an oil pressure switch is used, a jumper across the switch will activate the regulator.
3. After allowing time for the regulator's start-up delay, place the head of a steel screwdriver near the nut on the pulley shaft or near the rear bearing of the alternator. There should be substantial magnetic pull. If a magnetic field is present, the voltage regulator, alternator brushes and rotor are likely to be working properly.

**Test B** - If there is little or no magnetic pull at the pulley shaft or at the rear bearing, initiate the following test:

1. With the key off and the engine off, remove the large harness plug from the regulator.
2. Insert the end of a short length of electrical wire to the RED connector slot of the regulator harness and the other end of the wire to the BLUE connector slot. (See Figure 24.) This bypasses the regulator and tests the alternator and the harness.
3. Using your steel screwdriver, inspect for a magnetic field as described above.
4. With your voltmeter, check for voltage on the blue wire at the alternator. If voltage does not exist, the harness may be at fault. If voltage does exist at the harness, but no magnetism is present, the alternator is likely to be malfunctioning.

If a magnetic field is present. Both harness and alternator brushes and rotor appear to be working properly. If no magnetic field is present, proceed with the next test.

**Test C** - Testing the actual output of the alternator is known as "Full Field Testing". This can be accomplished by jumping a positive 12VDC current to the field terminal at the rear of the alternator. This test eliminates both the regulator and the harness, making it easier to isolate your investigation to the alternator. **CAUTION:** Ensure that all voltage sensitive equipment is turned off prior to starting the engine. Voltage is unregulated during this test and could damage sensitive electronics. **DO NOT** let the engine run any longer than necessary to detect charging. If the system is not charging, remove the alternator and have it inspected by a qualified alternator shop, or call Balmar for warranty evaluation.

To test the alternator:

1. Clip a jumper wire to the positive post of the alternator, or on the battery side of the isolator (if an isolator is in use). Use a SHIELDED alligator clip for post attachment. Unintentional contact between the alligator clip and the alternator case could result in damage to your electrical system.
2. Disconnect the field/stator plug from the rear of the alternator and attach the other end of the jumper wire to the alternator's Field terminal (F). Attach a female spade connector to the field end of the wire for a solid connection. **CAUTION:** Do not allow the wire to contact the case while it is attached to the positive post. The case is grounded and severe damage could occur.
3. The regulator is now bypassed. When the ignition is engaged and the motor is started, the voltage should rise and charging current should be present.
4. The motor should be run long enough to determine that charging voltage is present. **UNREGULATED VOLTAGE CAN RISE QUICKLY.** Do not allow extended unregulated charging to occur without carefully monitoring voltage levels.

If the alternator fails to generate voltage during field testing, a malfunction of the alternator is likely. Contact your local alternator repair shop or Balmar's technical service staff for recommendations.

## CONCLUSION

If your readings differ substantially from the "Expected Readings" listed in the charts above, the regulator may be malfunctioning, or there may be a continuity problem. Contact our technical support staff at (360) 435-6100. If you determine that repair service is necessary for either your alternator or regulator, please gather the following information before contacting our service technicians.

1. Make and model of alternator.
2. Model of voltage regulator and date of mfg (date punched on rear side label of regulator).
3. Voltage readings on red, brown and blue wire at regulator with engine off, key on.
4. Voltage readings on red, brown and blue wire at regulator with engine running at a fast ideal 1400 rpm.

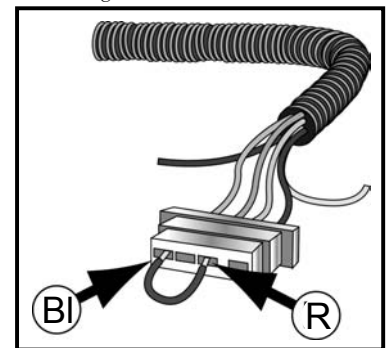
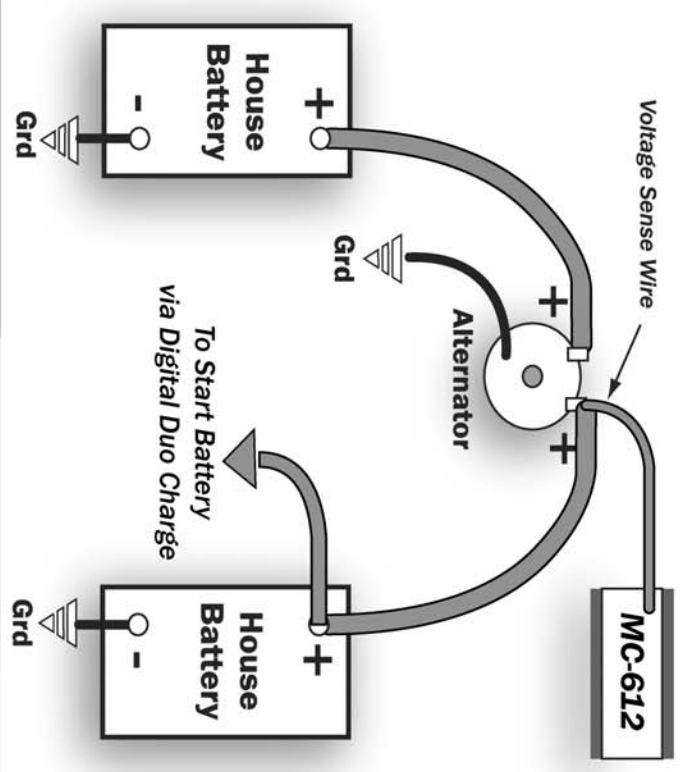

Figure 24 - Jumping power wire to field.

# Suggested Wiring Options (Single/Dual Outputs)

**Dual-Output Alternator**  
Start/Two House Battery Banks - With Duo Charge



**Single Output Alternator**  
Start/Two House Battery Banks - With Duo Charge

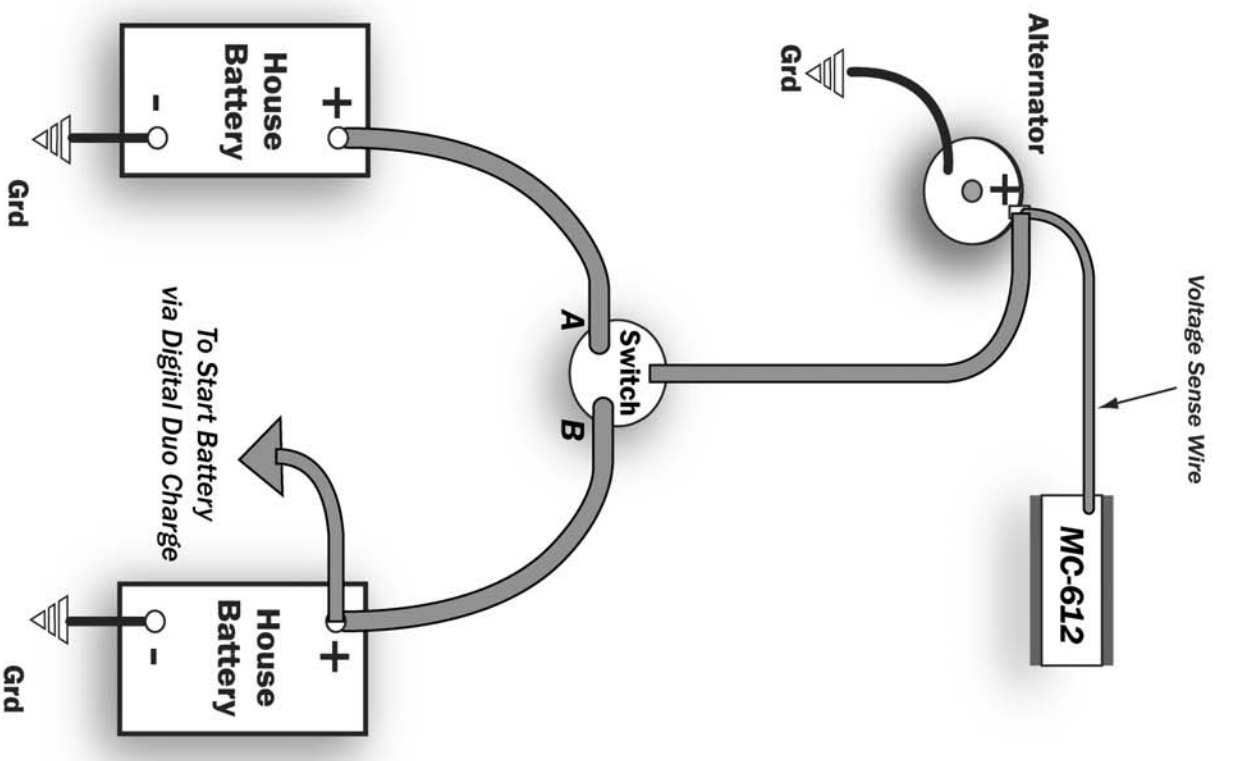

**Single Output Alternator w/Isolator**  
Start/Two House Battery Banks - With Duo Charge

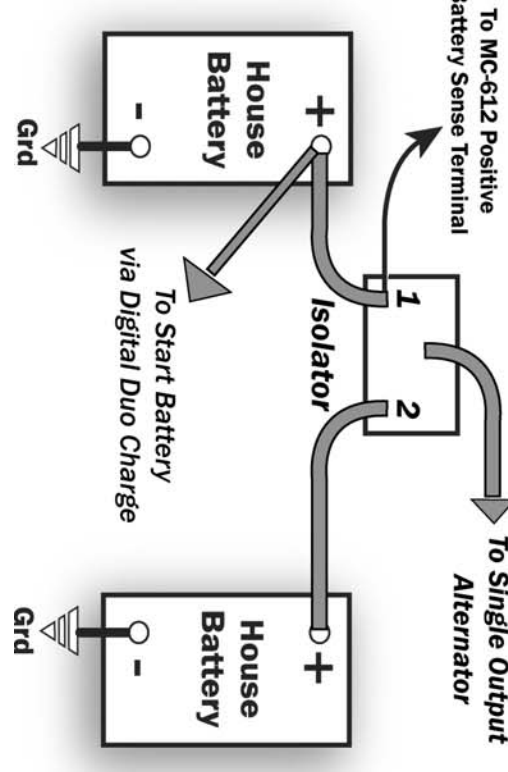

# Suggested Wiring Options (Continued)

**Twin Engines / Dual Alternators / Dual Regulators  
House / Start Battery Banks - With Centerfielder & Duo Charge**

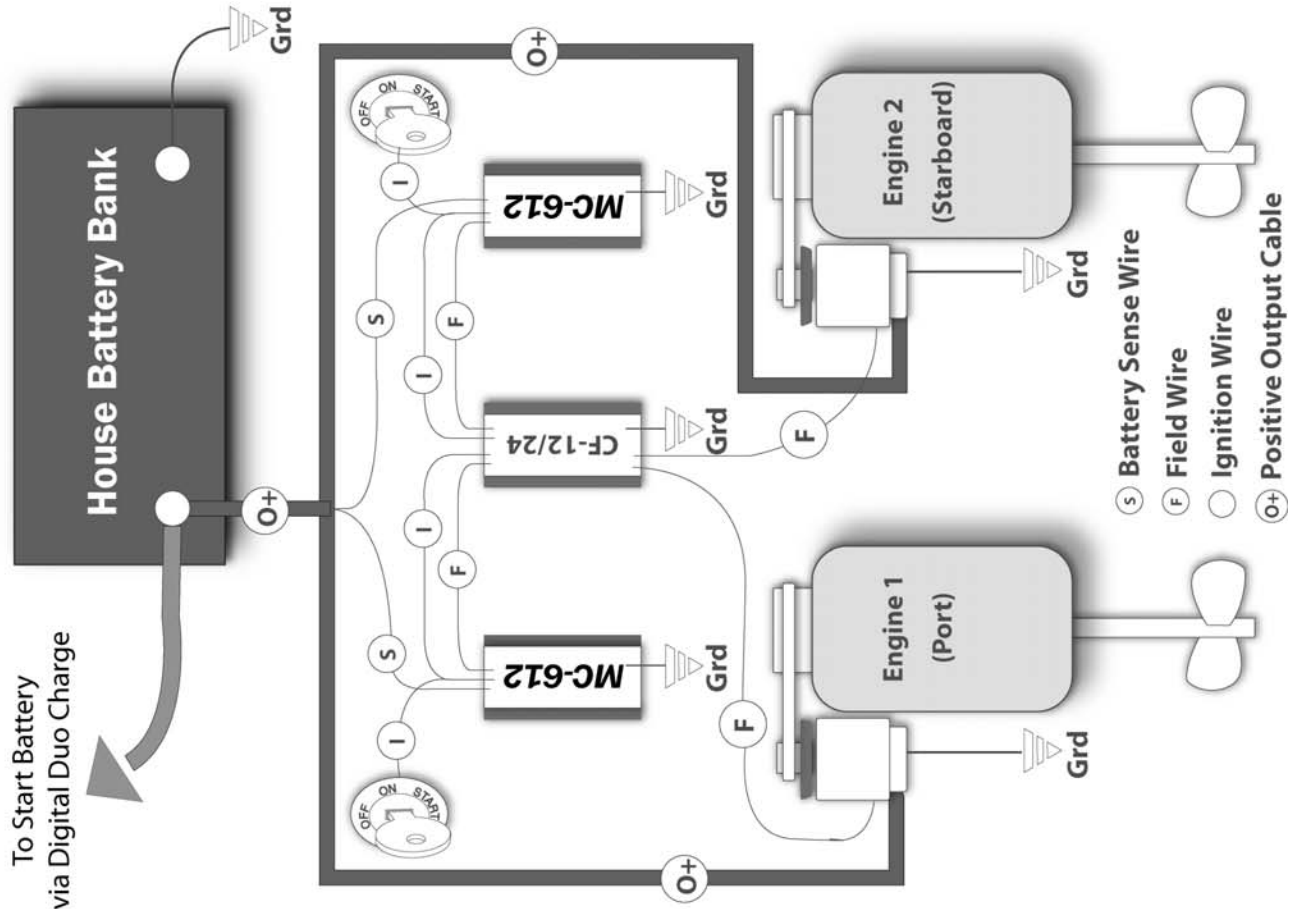

To Start Battery  
via Digital Duo Charge

- Ⓢ Battery Sense Wire
- ⓕ Field Wire
- ⓐ Ignition Wire
- ⓐ+ Positive Output Cable

**Single Alternator / Single Regulator  
Start/House Battery Banks - With Duo Charge**

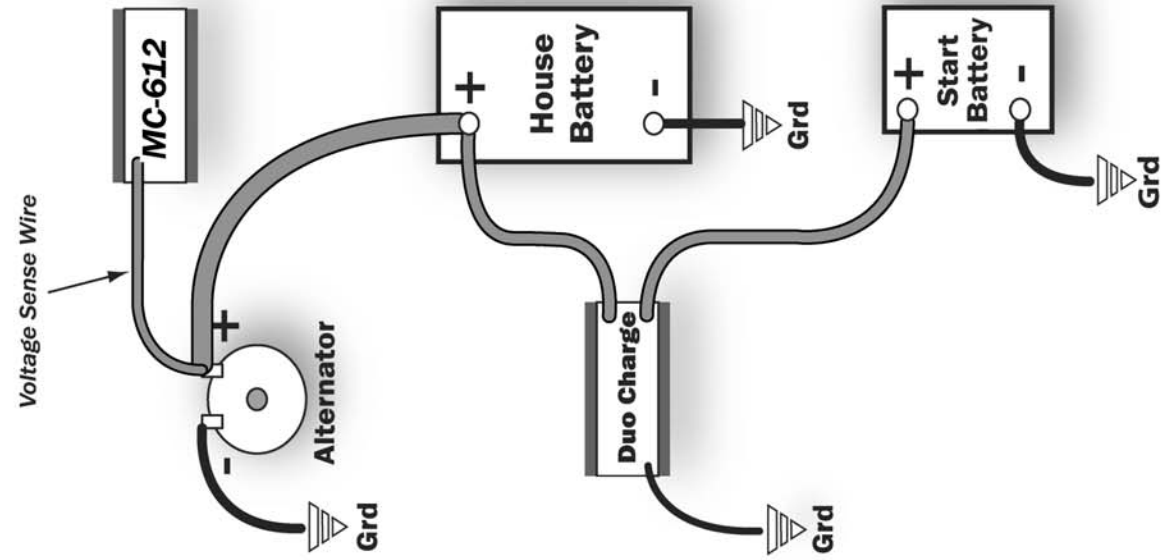

# Max Charge MC-612 Quick Installation Instructions

## BALMAR®

The MC-612 can be installed with very little difficulty if installation instructions are followed carefully. If you are unaccustomed to marine electrical installations, we recommend a licensed marine electrician. See Page 2 before starting. To install:

1. Mount the regulator in a dry, well-ventilated location, well away from hoses and exhaust manifolds which may cause damage to the regulator or wiring. **Avoid areas of heat and/or high vibration.**
2. The RED wire (in the harness) powers the regulator. Attach at the positive output terminal at the back of the alternator. If an isolator is used, this wire must be located on the battery side of the isolator. On a 12V system, this wire can carry 8 amps and must be protected by a 10-amp fuse. A fuse is included with the wiring harness.
3. The POSITIVE battery sense wire, as shown in the illustration at right, monitors battery voltage. The positive sense wire should be connected 1) at the positive output of the alternator, 2) at the battery, if only one battery is being used; 3) at the "common" terminal of the battery selector switch for multi-bank charging; or 4) on the isolator terminal for the largest battery bank (if isolator is used). This wire is user supplied and should be 16-gauge. Spade and ring terminals, and a 1-A inline fuse are provided. **The positive battery sense wire MUST be connected for the regulator to work.** Refer to regulator side label for terminal locations. Caution: Sense wires MUST always see the battery being charged. **Be sure to observe polarity.**
4. The BROWN (ignition) wire activates the regulator when +12VDC is applied to the system. Attach the BROWN wire to a switched +12VDC source. The auxiliary side of the ignition switch, or an independent (ungrounded) oil pressure switch are both acceptable connection points. A toggle switch may be added to this circuit to shut down the alternator load in cases where maximum propulsion is needed.
5. Attach the Ford-type harness plug to the regulator (see illustration). The second BLACK (ground) wire in the harness attaches to the Negative Battery Sense Terminal.
6. Plug duplex plug with BLUE (field) and White (stator) wires into rear of alternator.

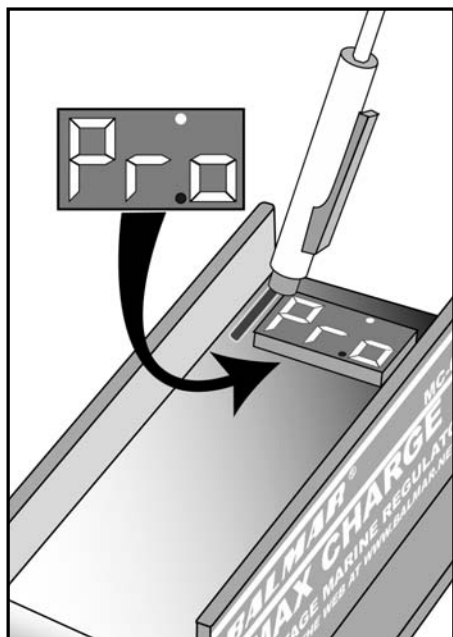
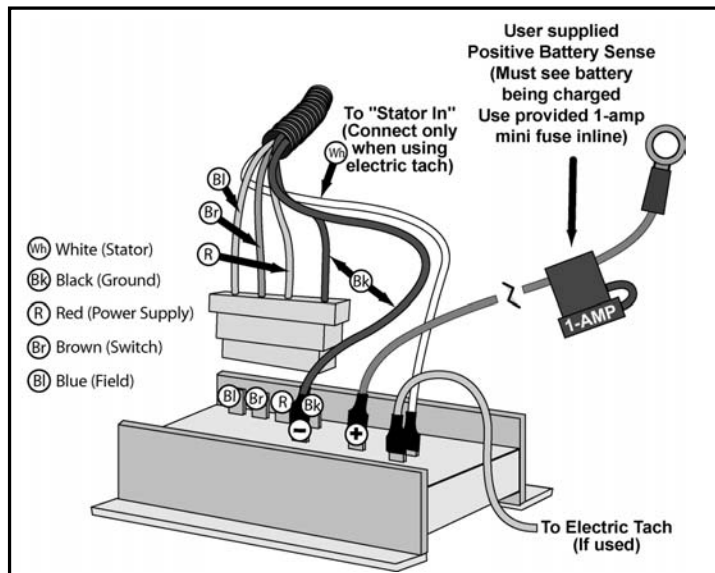

7. Plug the other end of the WHITE wire into the Stator Terminal on the regulator (see side label for locations of these and other terminals). Tach Terminal on the regulator provides pulse for electric tachometer, if desired.

The MC-612 is factory preset for use with most battery types. For optimal charging, we recommend choosing one of the six battery-specific selectable programs discussed on Page 4 of the installation manual. Program choices are: 1) Universal Factory Program, 2) Flooded Deep-Cycle, 3) Gel Cell, 4) AGM, 5) Optima, 6) Standard Flooded, and 7) for Halogen and voltage sensitive applications. To enter a battery program.

1. Activate the preset program mode by placing the magnetic screwdriver (or pencil magnet) as shown at left. The white dot at the top of the display indicates the switch is activated.
2. The "Pro" display appears, followed by the cycling of the battery type codes. When your desired battery type is displayed, release the switch by removing the magnet.
3. Should you need to alter your choice, activate the switch again with your magnet and release as soon as your desired program is displayed.
4. The "Pro" code will display, followed by the "SAV" code, once the switch is released. The regulator is now set for your battery type.